

Елена Бортникова razykras.ru

ТЕТРАДЬ

МОИ ПЕРВЫЕ ПРОПИСИ



ДЛЯ ДЕТЕЙ

5-6

ЛЕТ

ББК 74.3
Б82

Е.Ф. Бортникова.
Б82 МОИ ПЕРВЫЕ ПРОПИСИ (для детей 5–6 лет): тетрадь. —
Екатеринбург: ООО «Литур-опт», 2013. — 32 с. — (Учимся иг-
рая).

Уважаемые родители и педагоги!

Предлагаем вашему вниманию задания по развитию навыков письма, которые помогут вашему ребенку успешно подготовиться к обучению в школе.

Упражнения направлены на развитие мелкой моторики, координации движений руки, зрительного восприятия широкой и узкой строк в прописях. Работая в тетради, дети научатся писать различные элементы письменных букв.

На каждой странице детям предлагается сначала заштриховать рисунок, затем обвести предметы, линии или элементы букв по пунктирной линии, а потом нарисовать их самостоятельно.

Все задания в тетради надо выполнять остро заточенным простым карандашом.

Тетрадь рассчитана на совместную работу взрослых и детей. Она может быть использована в детских дошкольных учреждениях.

Желаем успеха вашему ребенку!

ISBN 978-5-9780-0120-4

© Е.Ф. Бортникова, 2010
© Литур-опт, 2013
© Издательский дом «ЛИТУР», 2013
© Издательский дом «ЛИТУР»
(оформл.), 2013

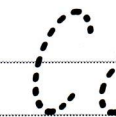
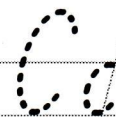
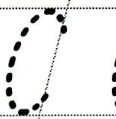
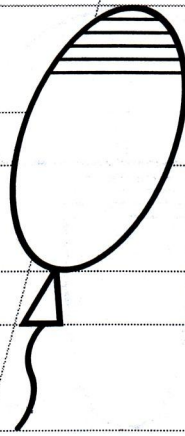
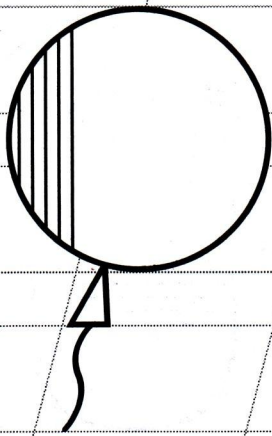

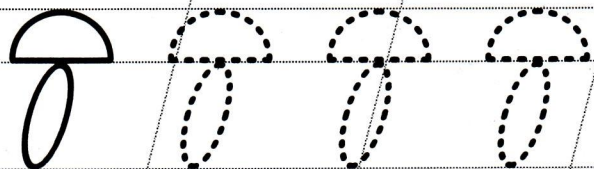
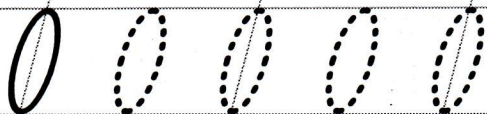
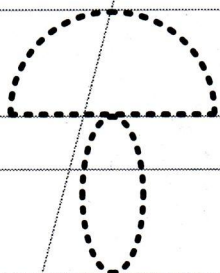
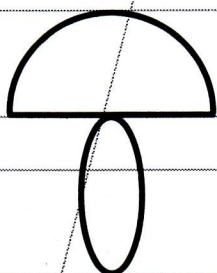
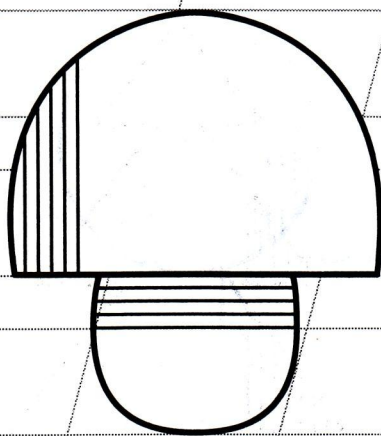
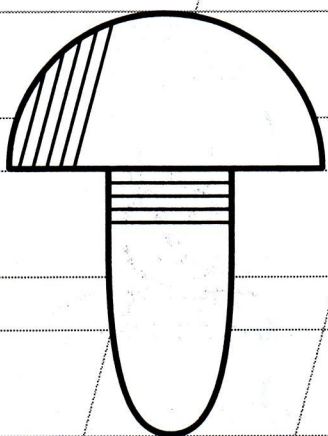

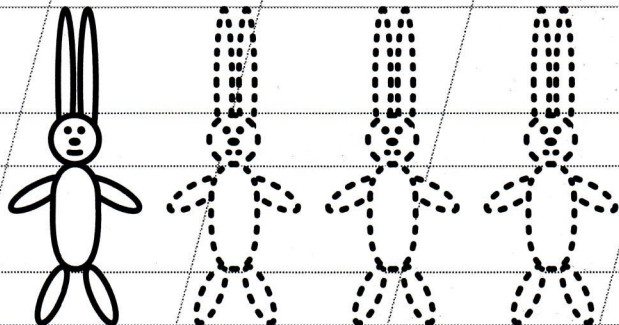
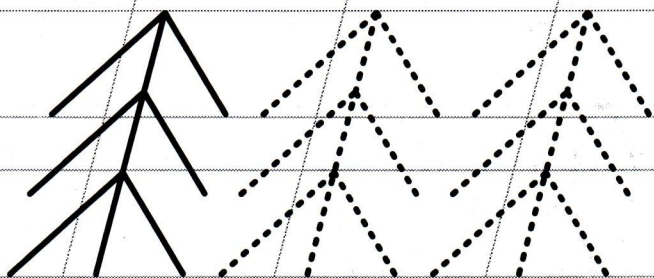
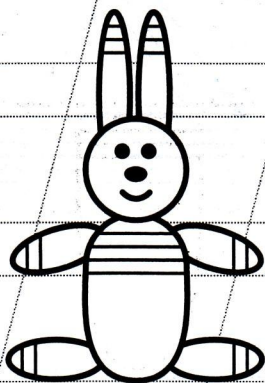
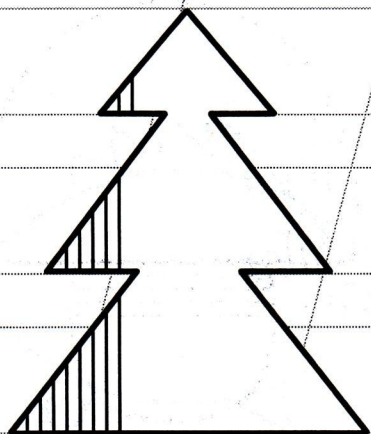

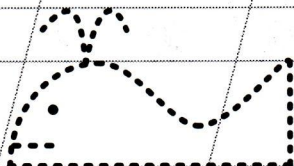
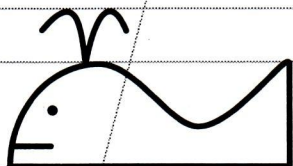
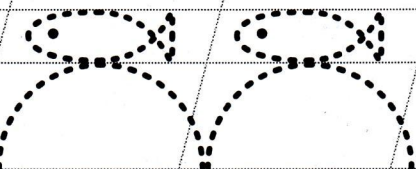
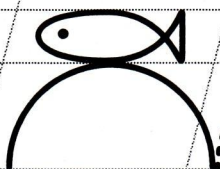
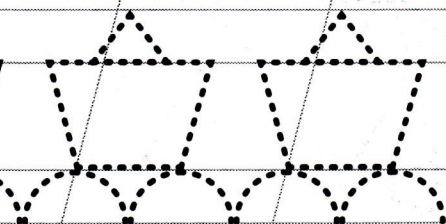
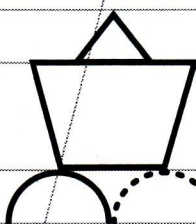
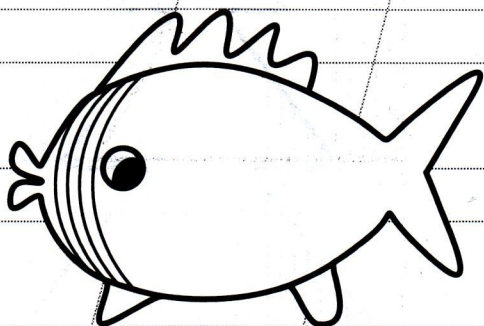
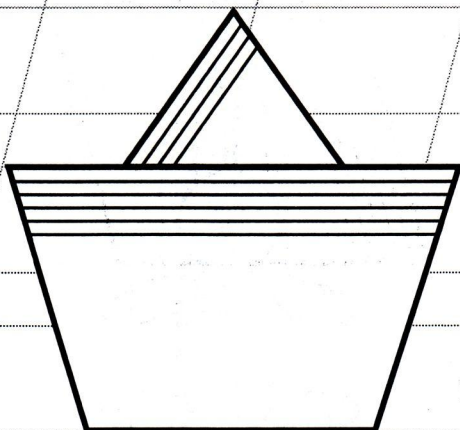

Cc

Cc Cc Cc

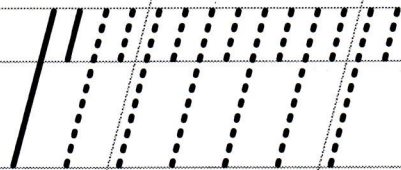
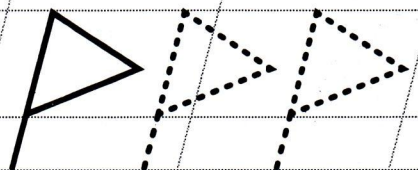
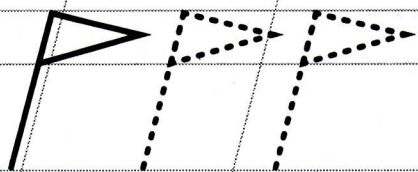
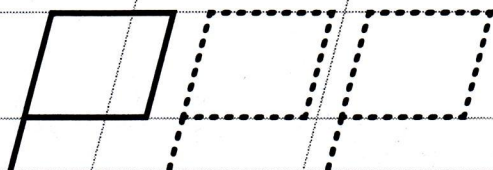
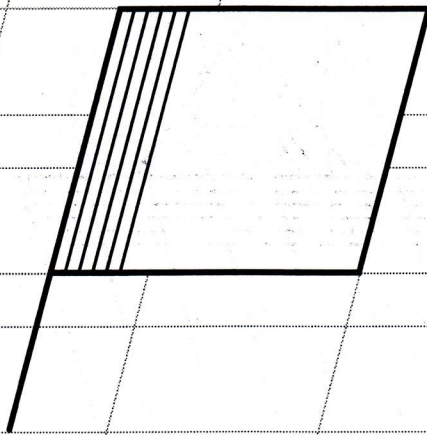
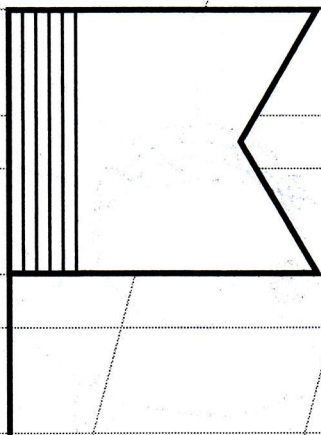

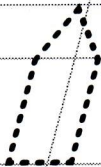
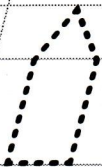
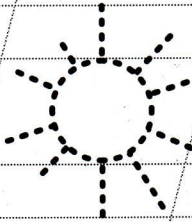
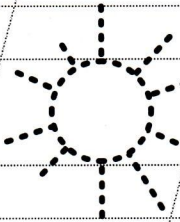
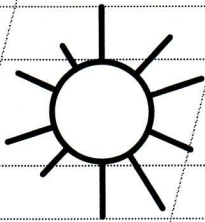
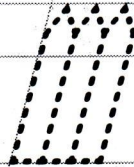
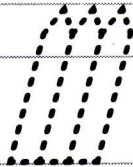
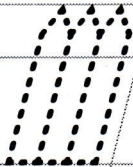
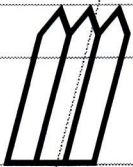
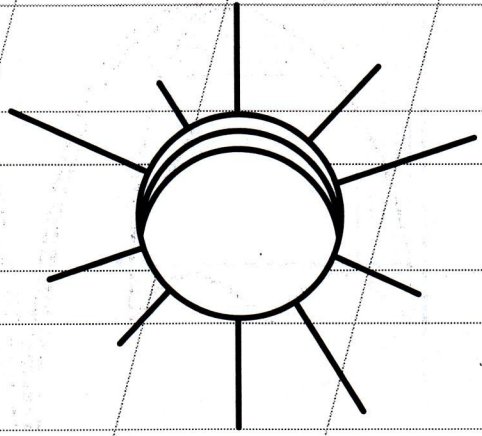
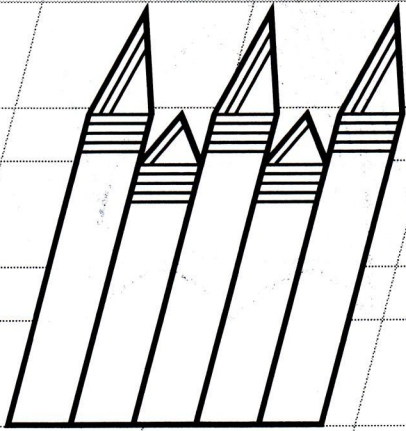

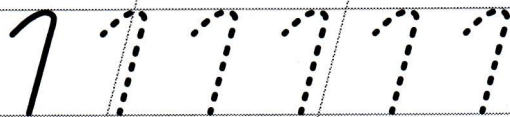
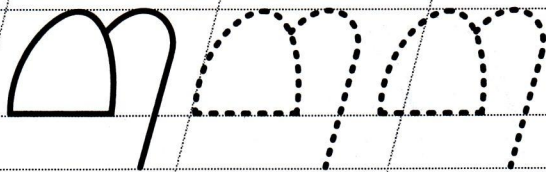
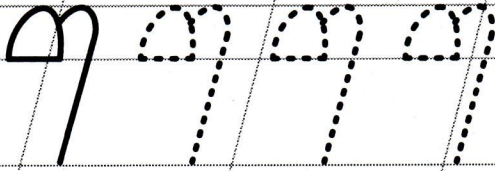
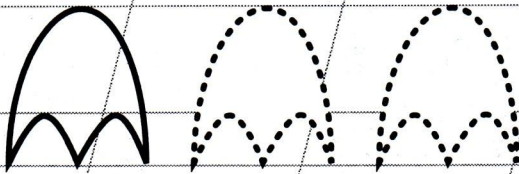
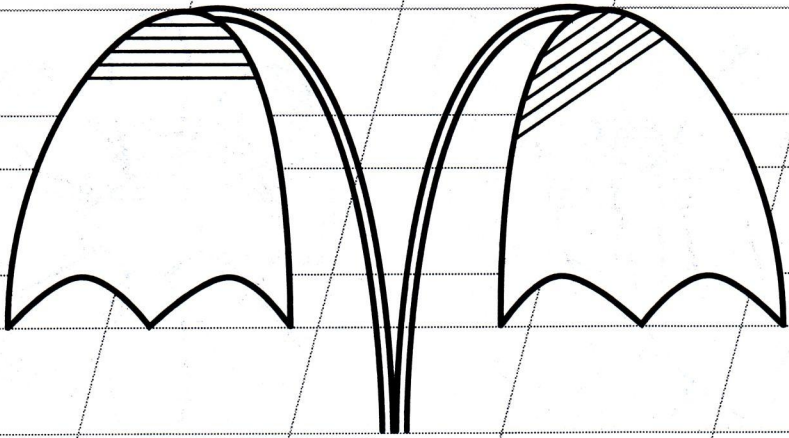

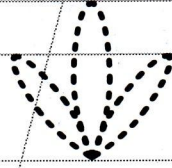
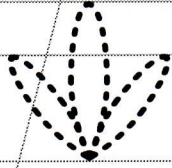
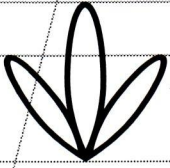
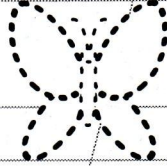
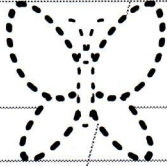
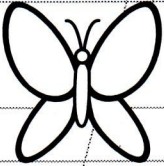
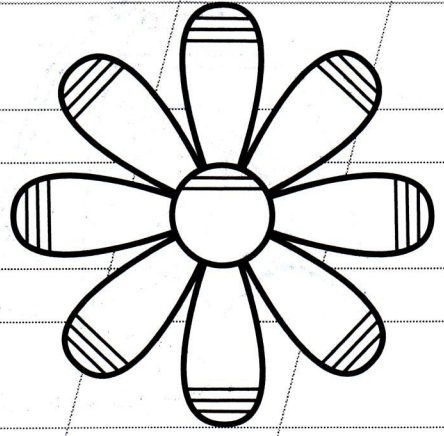
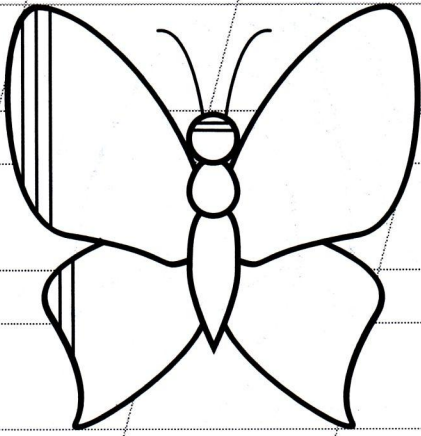

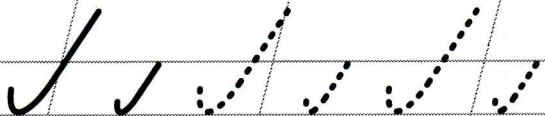
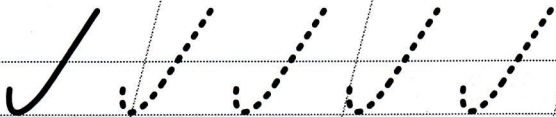
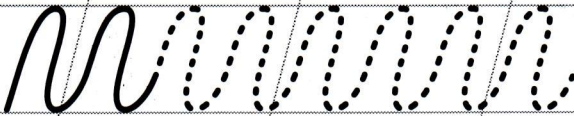
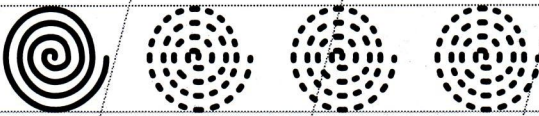
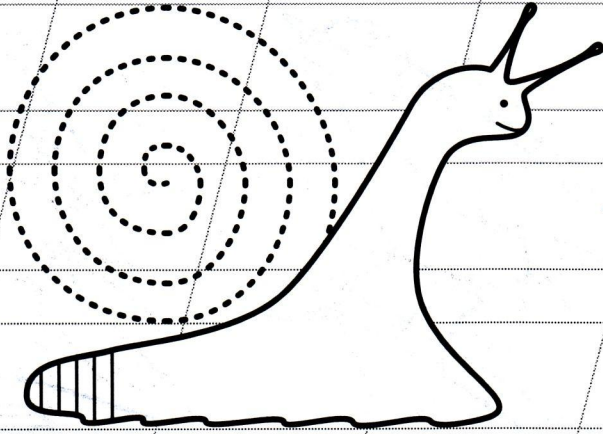

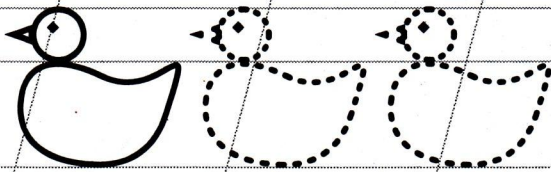
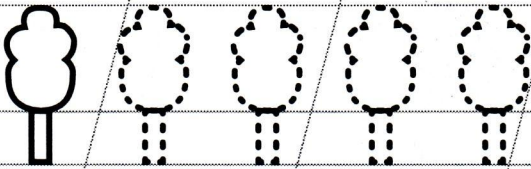
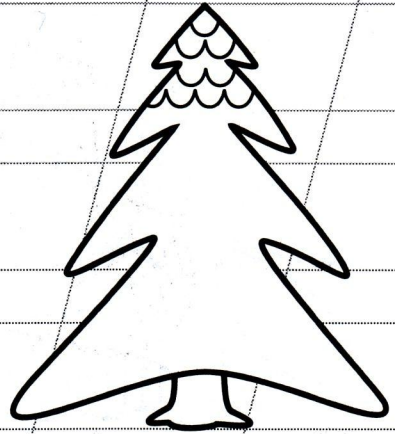
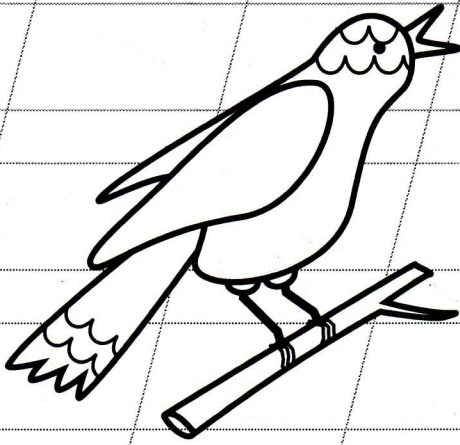

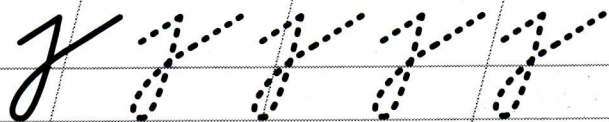
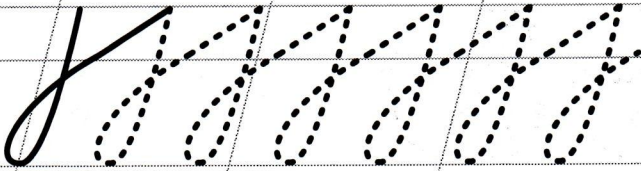
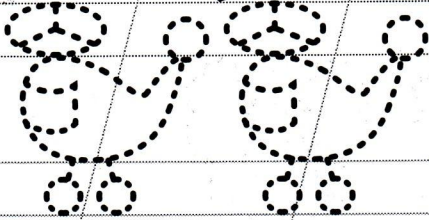
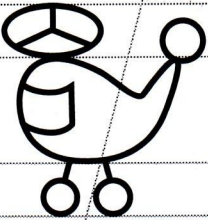
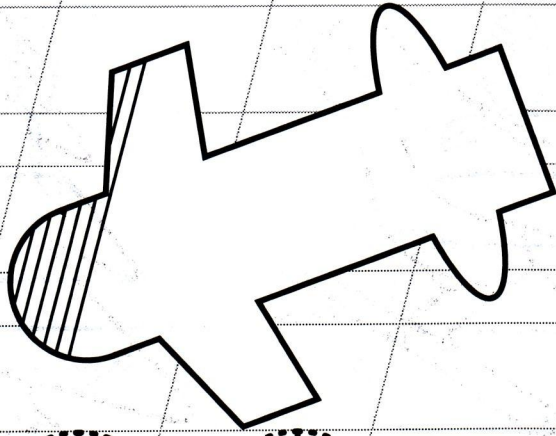

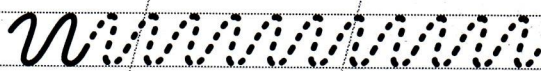
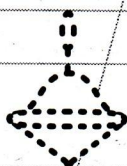
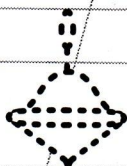
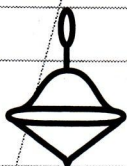
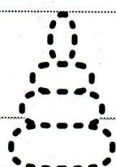
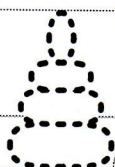
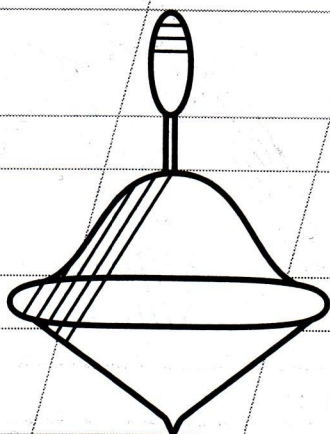
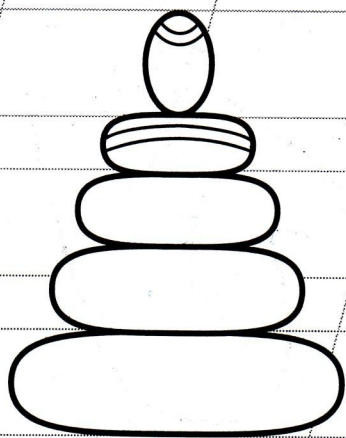

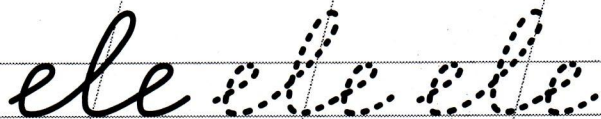
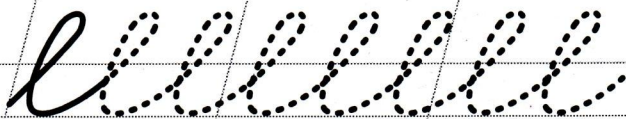
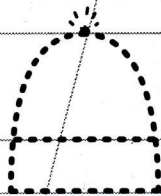
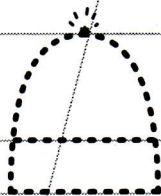
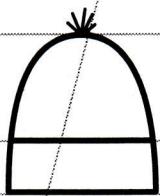
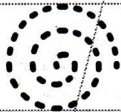
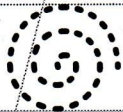
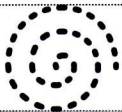
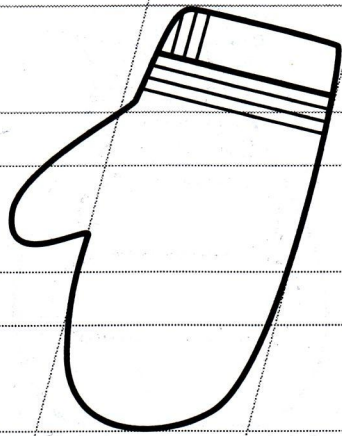
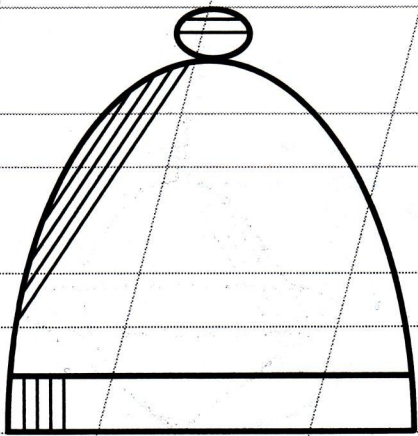

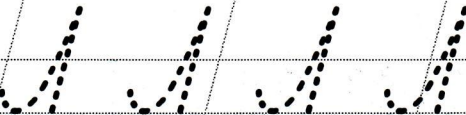
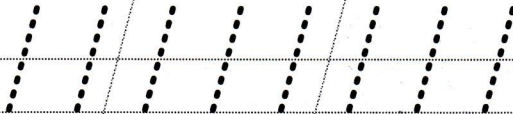
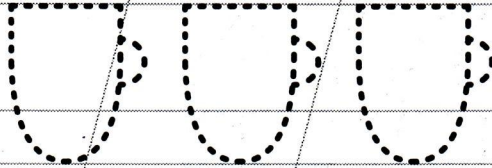
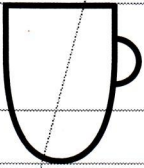
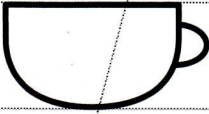
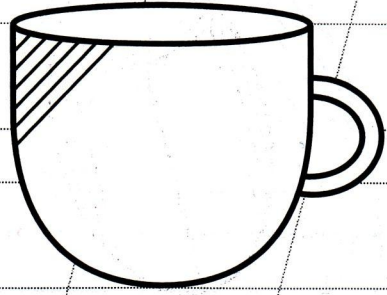
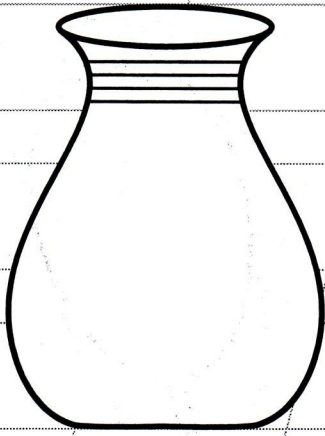

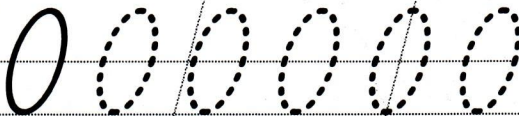
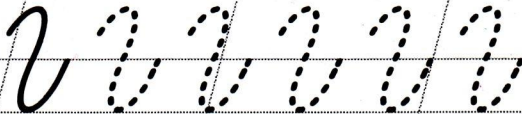
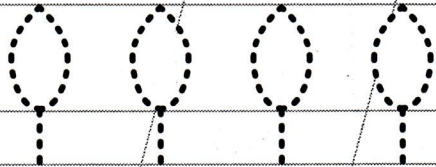
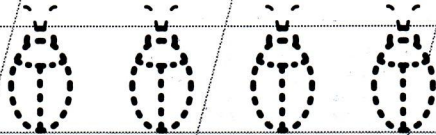
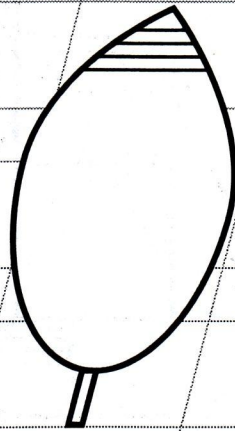

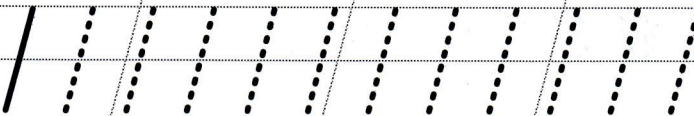
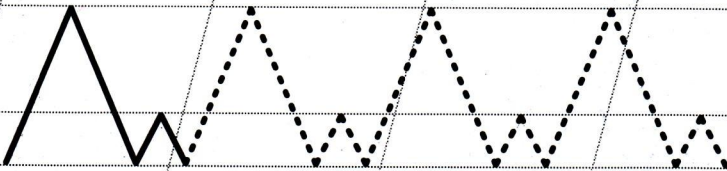
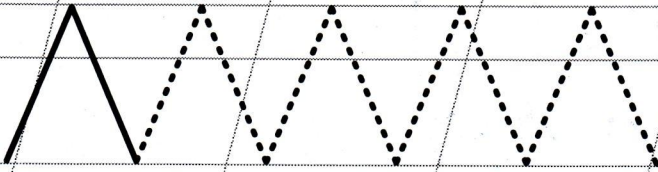
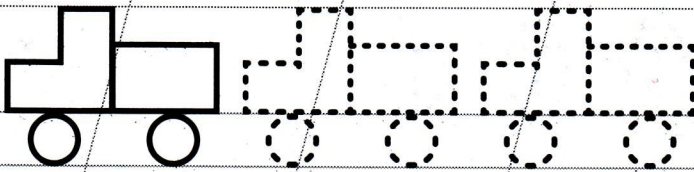
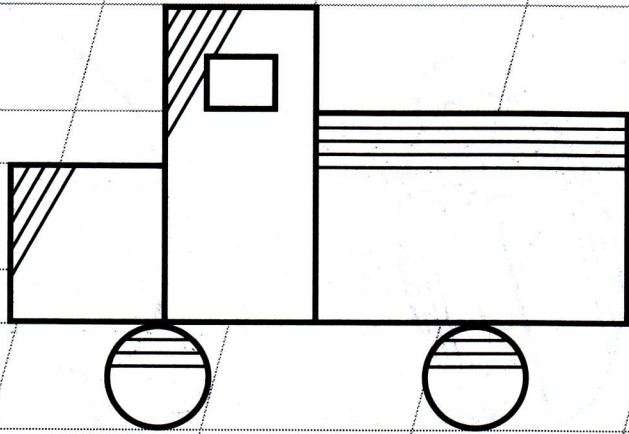

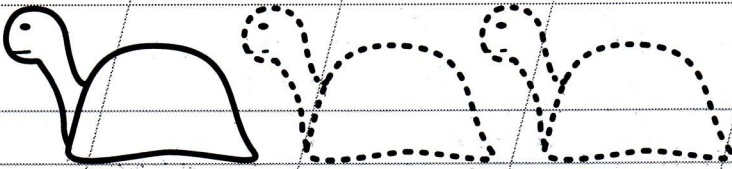
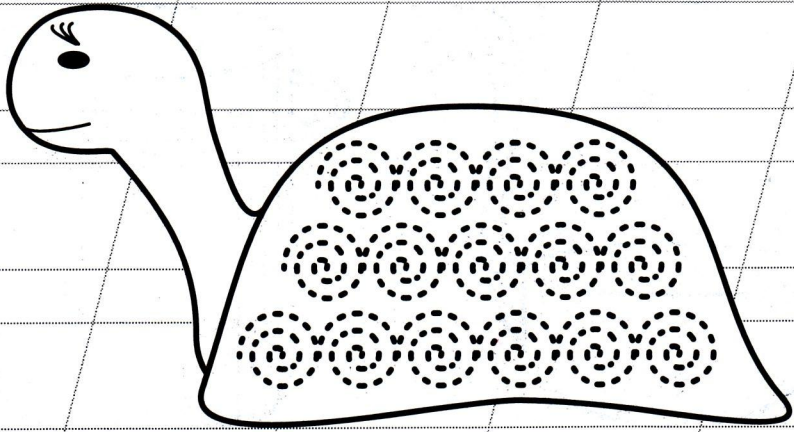

W W W W

v v v v

z z z z z z z z z z

n n n n n n n n n n

l l l l l l l l l l

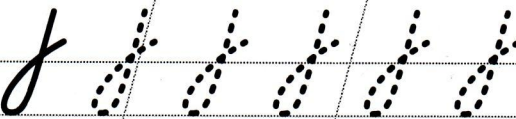
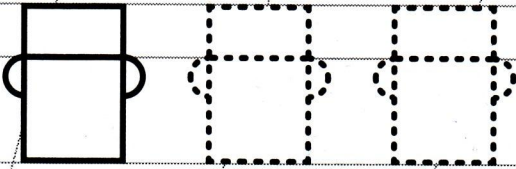
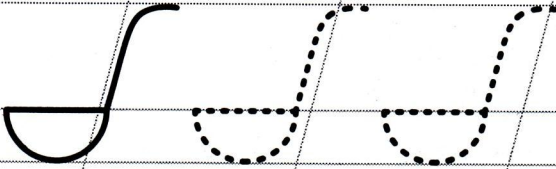
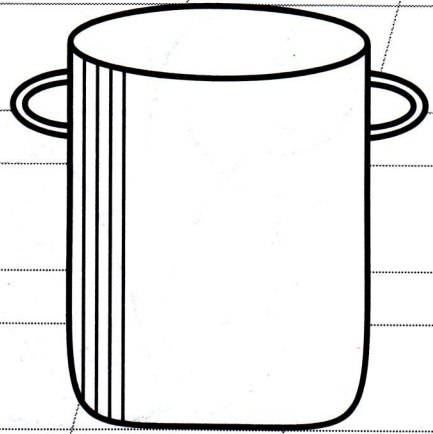
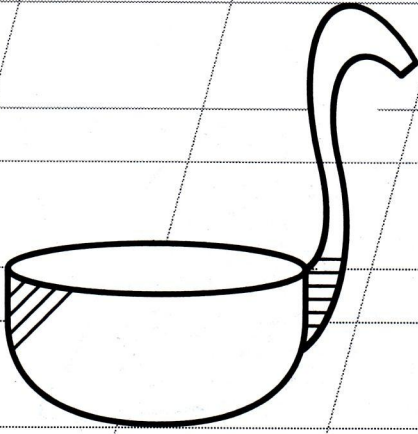

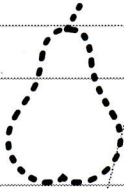
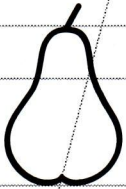
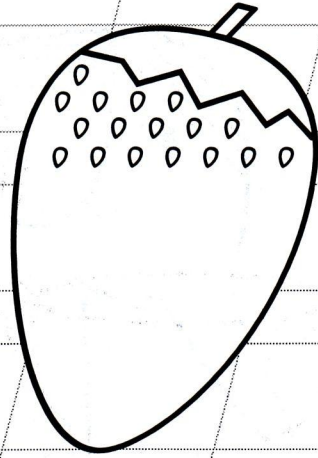
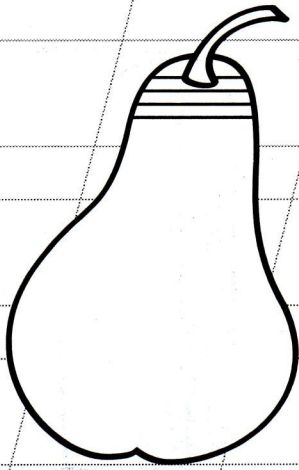

ol

ol

ol

ol

ol

ol

p

p

p

p

p

p

p

b

b

b

b

b

b

b

b

pb

pb

pb

pb

pb

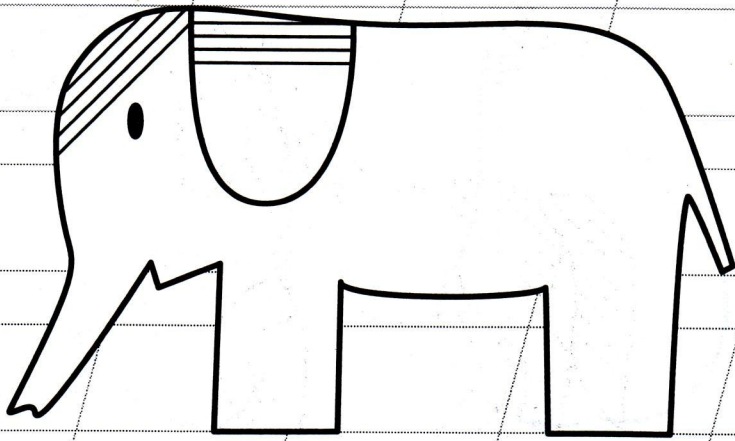

Handwriting practice row 1: A solid cursive 'r' followed by five dotted cursive 'r's for tracing.

Handwriting practice row 2: A solid cursive 'r' followed by four dotted cursive 'r's for tracing.

Handwriting practice row 3: A solid cursive 'r' followed by five dotted cursive 'r's for tracing.

Handwriting practice row 4: A solid cursive 'r' followed by four dotted cursive 'r's for tracing.

Handwriting practice row 5: A solid cursive 'r' followed by four dotted cursive 'r's for tracing.

Handwriting practice row 6: A solid cursive 'l' followed by five dotted cursive 'l's for tracing.

Handwriting practice row 7: A solid cursive 'l' followed by six dotted cursive 'l's for tracing.

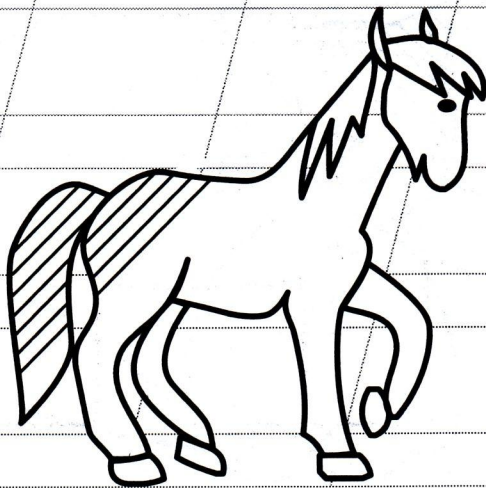

n n n n n n n n

m m m m m m m m

u u u u u u u u

w w w w w w w w

W W W W W W W W

n n n n n n n n

UN UN UN

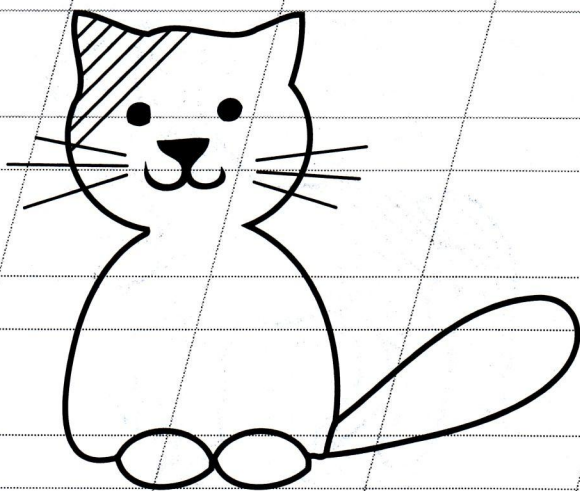

r r r r r r r

z z z z z z z

// // // // // //

e e e e e e e

l l l l l l l

v v v v v v v

e l e l e l e l



l 7 l 7 l 7 l 7 l 7

L 7 L 7 L 7 L 7

2 2 2 2 2 2

l L l L l L

7 7 7 7 7 7

u u u u u u

u l u l u l u l



o o o o o o o

o o o o o o o

c c c c c c c

C C C C C C C

x x x x x x x

X X X X X X X

x X X X X X X

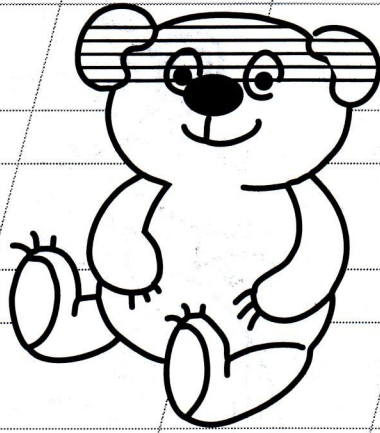

✓ / / / / / / /

l l l l l l l l

h h h h h h h h

✓ / / / / /

l l l l l l

h h h h

h h h h

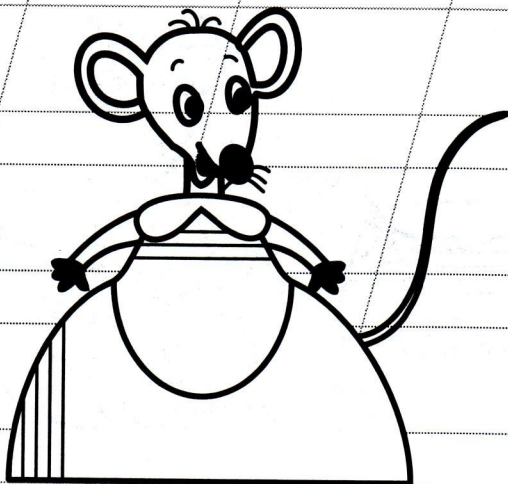

f f f f f f f

e e e e e e e e

l l l l l l l

h h h h h

7 7 7 7 7 7 7

z z z z z z z

2 2 2 2 2

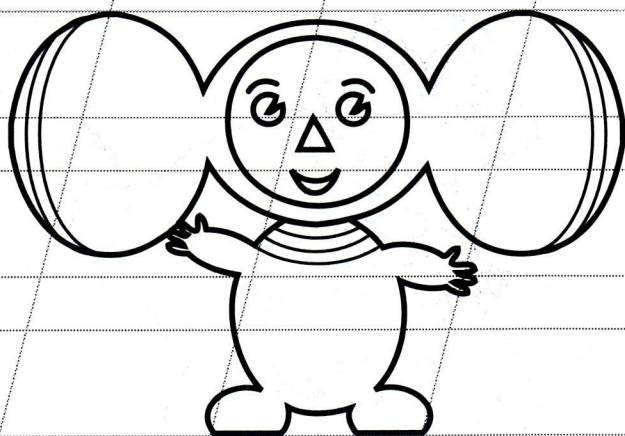

Р Р Р Р Р Р Р Р

л л л л л л л л

н н н н н н н н

о о о о о о о о

О О О О О О

н о н о н о н о

о О о О о О о О

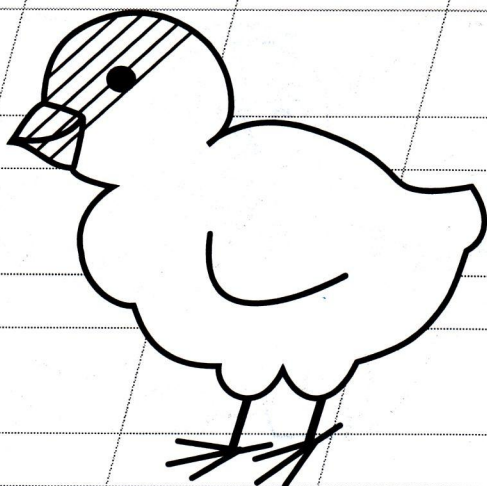

U U U U U U

l l l l l l

g g g g g g

g g g g g g

u u u u u u

b b b b b b

b b b b b b

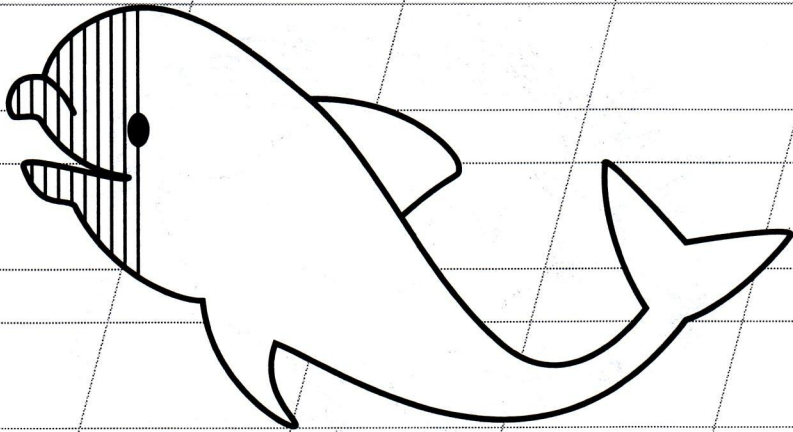

m m m m m m m m m m m m m m m m

M M M M M M M M M M M M M M M M

L L L L L L L L L L L L L L L L

J J J J J J J J J J J J J J J J

b b b b b b b b b b b b b b b b

u u u u u u u u u u u u u u u u

W W W W W W W W W W W W W W W W

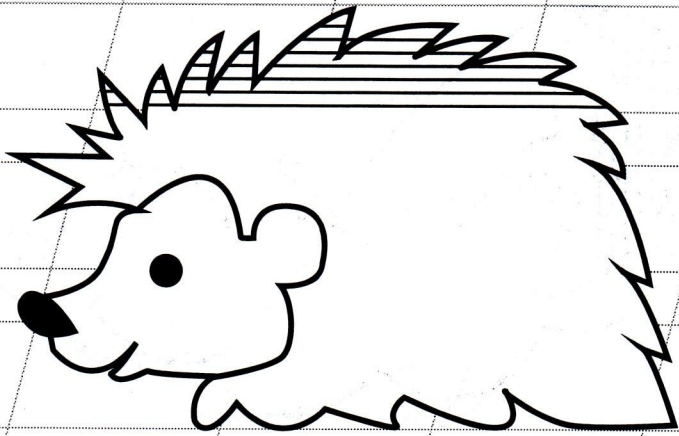

✓ / / / / / / /

∩ ∩ ∩ ∩ ∩

∩ ∩ ∩ ∩ ∩

∩ ∩ ∩ ∩ ∩

∩ ∩ ∩ ∩ ∩

∩ ∩ ∩ ∩ ∩

∩ ∩ ∩ ∩ ∩

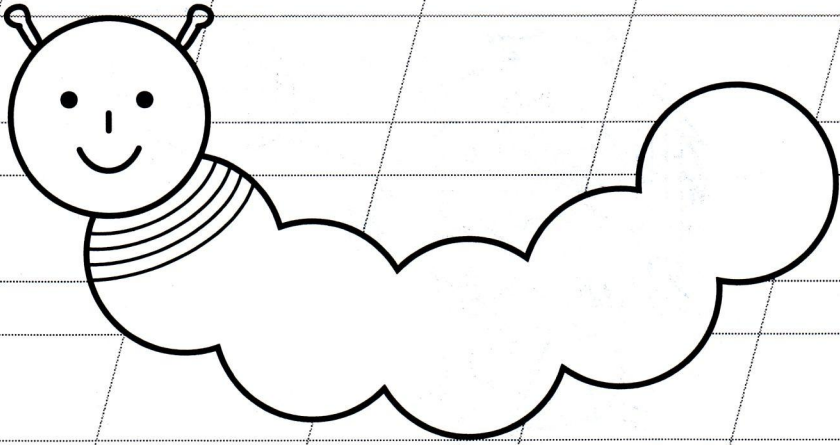

A A A A

N N N N

M M M

W W W W

U U U U

u u u u

A M A M



U U U U U U U

f f f f f f f

g g g g g g g

g g g g g g g

q q q q q q q

g l g l g l g l

o l o l o l o l